



**Intô** is a small collection of wall hung and freestanding Ubude cabinets and small Usisi stools that can also be used as side tables in the home, office or studio. Designed as a sustainable product by Deánne Viljoen, Intô is made from Birch plywood in our factory in the Garden Route of South Africa using CNC technology and the traditional woodworking skills of local craftsmen. Developed by De Steyl in collaboration with product developer Zani Marais and graphic designer Willem Viljoen.

# INTÔ MURAL

Inspired by the colourful geometric mural art of women from the Ndebele tribe of Southern Africa, the Mural range is a personal interpretation of the bold use of line and colour to create symbols to communicate.



**UBUDE** Available in 2 depths, a 320mm freestanding unit and a 150mm deep wall hung unit. Ubuide cabinet doors include printed finishes, as illustrated below.

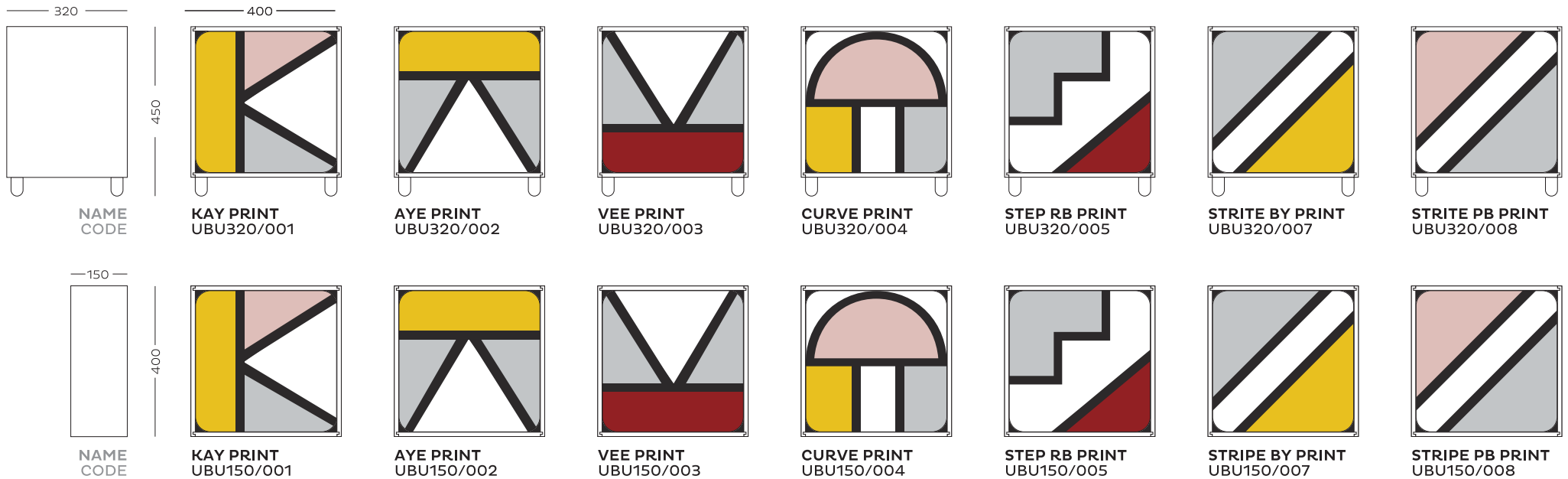

**USISI** Tops are finished in printed options as illustrated below.

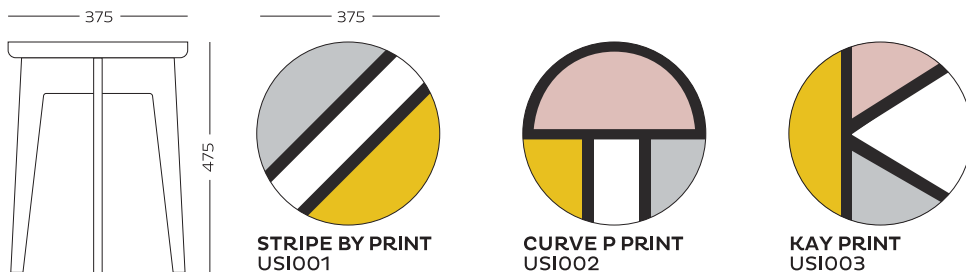

# INTÔ MURAL

Inspired by the colourful geometric mural art of women from the Ndebele tribe of Southern Africa, the Mural range is a personal interpretation of the bold use of line and colour to create symbols to communicate.

**intô**<sup>TM</sup>  
COLLECTION

## Umzali

The desk top is finished with printed pattern.

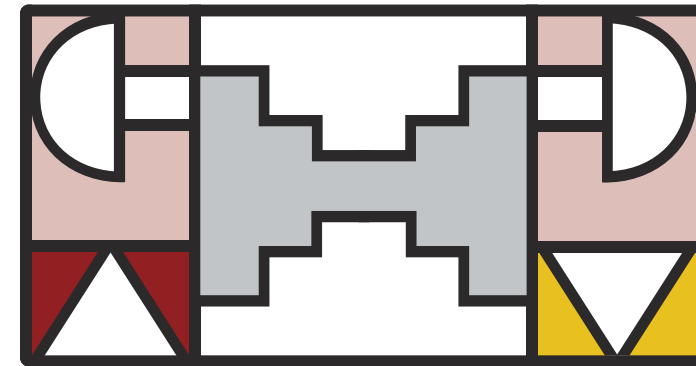
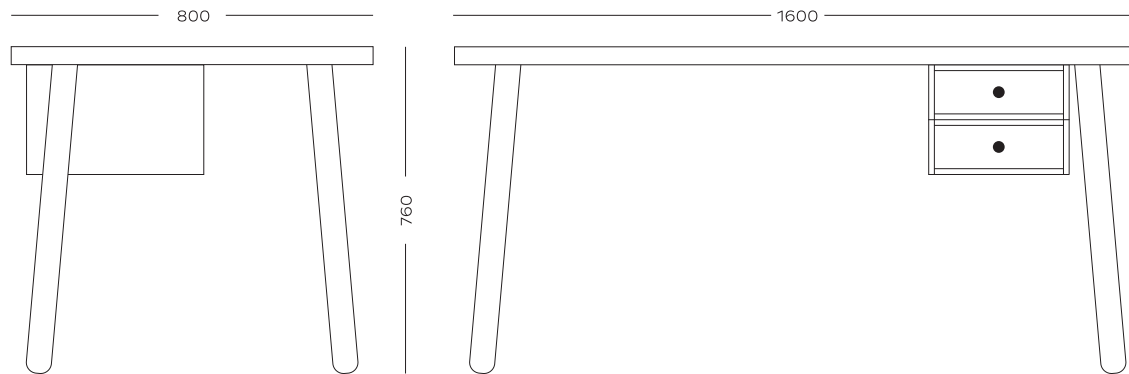

NAME **UMZALI DESK**  
CODE **UMZ001**

## Umama

The top is finished with either white or black HP laminate and features printed door as illustrated below.

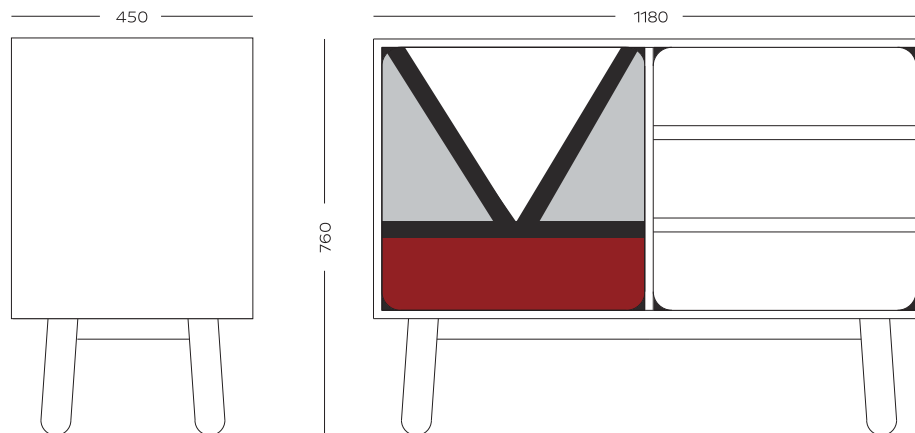

NAME **BLACK HPL TOP WITH VEE DOOR PRINT**  
CODE **UMA001/450MM**

# INTÔ DWEBA

To "carve, draw, hatch, scratch". Experimental range of monochromatic Intô products featuring line drawings printed in black ink on blonde wood or CNC engraving on black HPL laminate inspired by the Xhosa tribal tradition of adorning their cultural dress, Umbhaco, with beading and embroidery.



**UBUDE** Available in 2 depths, a 320mm freestanding unit and a 150mm deep wall hung unit. Ubude cabinet doors include printed finishes, as illustrated below.



NAME  
CODE

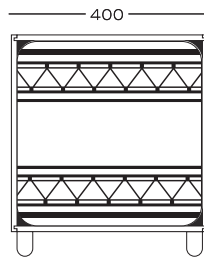

**TRIANGLE PRINT**  
UBU320/009

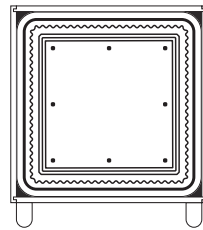

**BORDER PRINT**  
UBU320/010

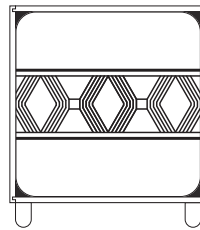

**KHOSI PRINT**  
UBU320/011

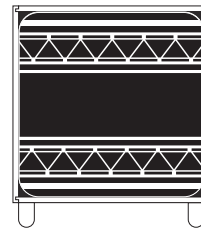

**TRIANGLE CARVE**  
UBU320/012

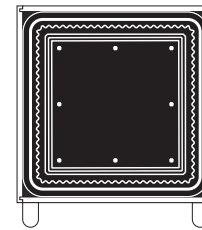

**BORDER CARVE**  
UBU320/013

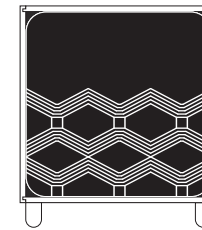

**KHOSI CARVE**  
UBU320/014

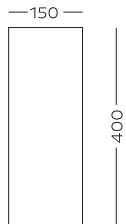

NAME  
CODE

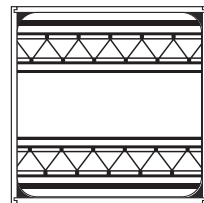

**TRIANGLE PRINT**  
UBU150/009

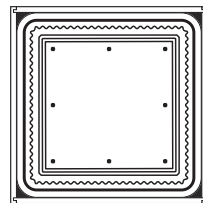

**BORDER PRINT**  
UBU150/010

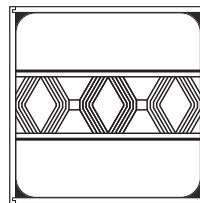

**KHOSI PRINT**  
UBU150/011

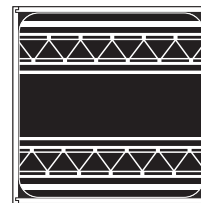

**TRIANGLE CARVE**  
UBU150/012

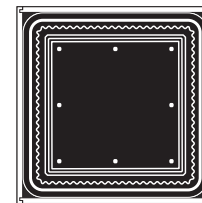

**BORDER CARVE**  
UBU150/013

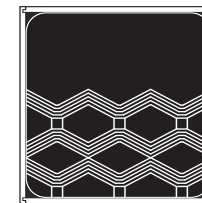

**KHOSI CARVE**  
UBU150/014

**USISI** Tops are finished in printed options as illustrated below.

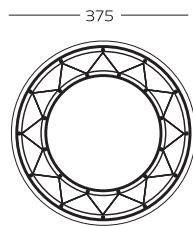
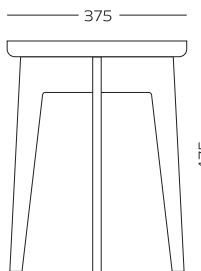

**TRIANGLE PRINT**  
USI004

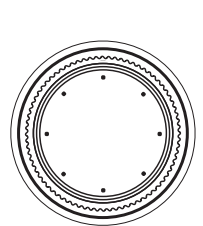

**BORDER PRINT**  
USI005

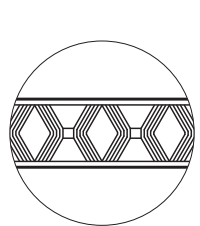

**KHOSI PRINT**  
USI006

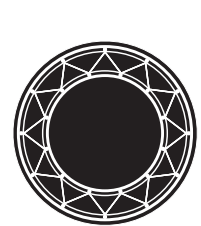

**TRIANGLE CARVE**  
USI007

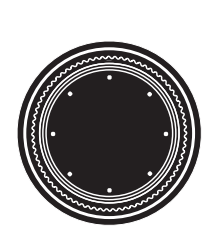

**BORDER CARVE**  
USI008

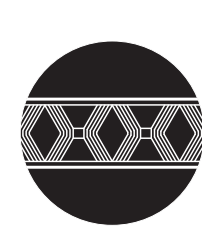

**KHOSI CARVE**  
USI009